

RU

UK

KK

EN

# Optimo 33L



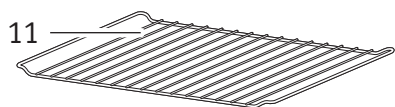
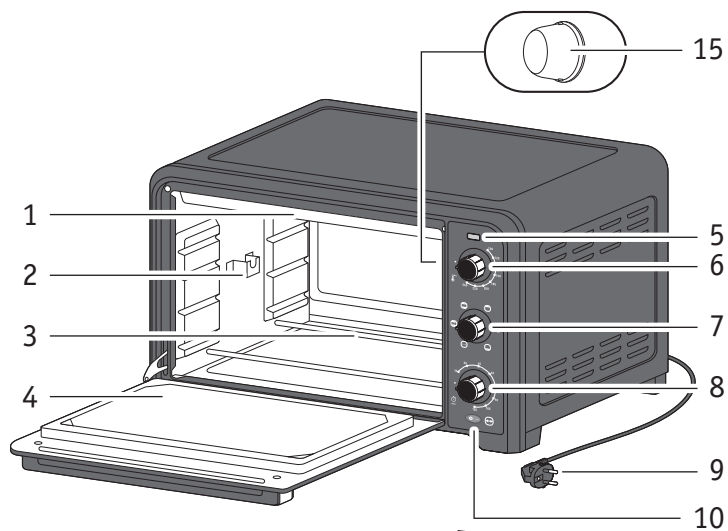

## ОПИСАНИЕ

- 1 Верхний нагревательный элемент
- 2 Алюминиевые стенки
- 3 Нижний нагревательный элемент
- 4 Двойная дверца
- 5 Индикатор работы
- 6 Регулятор температуры
- 7 Управление режимами
- 8 Управление таймером
- 9 Кабель питания
- 10 Включение вертела
- 11 Двусторонняя решетка гриля
- 12 Поддон
- 13 Вертел
- 14 Ручка для извлечения вертела
- 15 Внутренняя подсветка

## ОПИС

- 1 Верхній нагрівальний елемент
- 2 Алюмінієві стінки
- 3 Нижній нагрівальний елемент
- 4 Двошарові дверцята
- 5 Світловий індикатор живлення
- 6 Регулятор температури
- 7 Кнопка настройки функцій
- 8 Таймер
- 9 Шнур живлення
- 10 Вимикач гриля
- 11 Двобічна решітка-гриль
- 12 Деко
- 13 Рожен
- 14 Тримач гриля
- 15 Внутрішнє освітлення

## СИПАТТАМА

- 1 Жоғарғы қыздыру элементі
- 2 Алюминий қабырғалар
- 3 Төменгі қыздыру элементі
- 4 Қос қабырғалы есік
- 5 Жұмыс индикаторы
- 6 Температураны басқару түймесі
- 7 Функциялар түймесі
- 8 Таймер түймесі
- 9 Қуат сымы
- 10 Істік қосқышы
- 11 Аударуға болатын тор сәресі
- 12 Тамақ науасы
- 13 Істік бар құрал
- 14 Істік тұтқасы
- 15 Ішкі шам

## DESCRIPTION

- 1 Top heating element
- 2 Aluminium walls
- 3 Bottom heating element
- 4 Double-wall door
- 5 Power indicator light
- 6 Temperature control button
- 7 Functions button
- 8 Timer button
- 9 Power cord
- 10 Rotisserie switch
- 11 Reversible grill rack
- 12 Food tray
- 13 Rotisserie
- 14 Rotisserie handle
- 15 Inner light

1

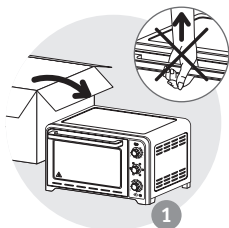

1

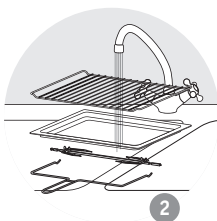

2

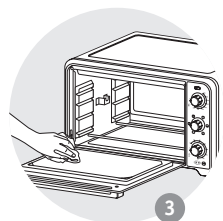

3

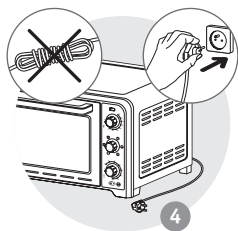

4

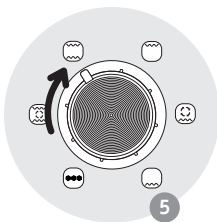

5

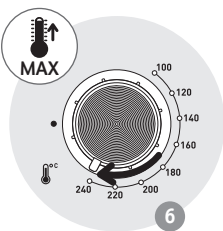

6

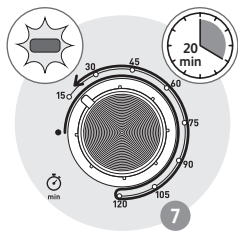

7

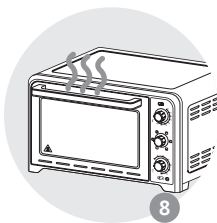

8

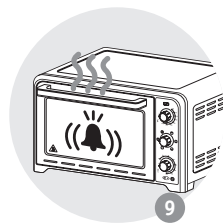

9

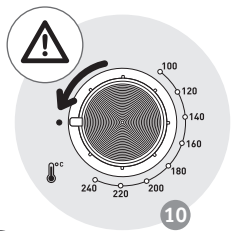

10

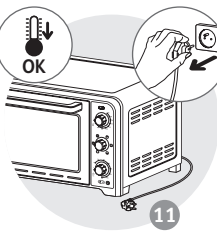

11

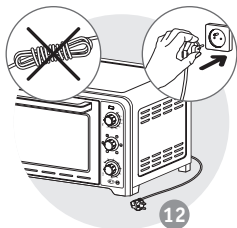

12

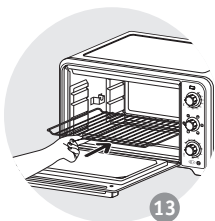

13

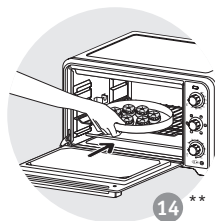

14 \*\*

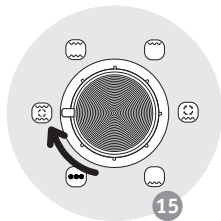

15

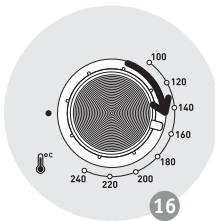

16

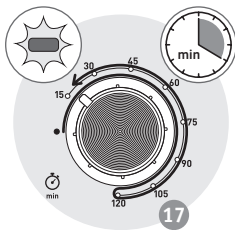

17

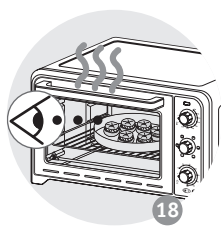

18

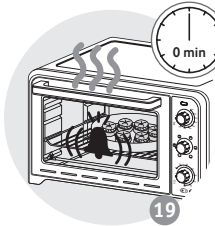

19

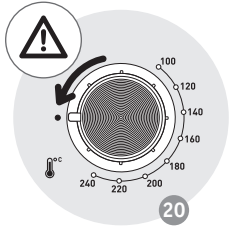

20

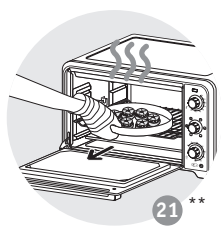

21 \*\*

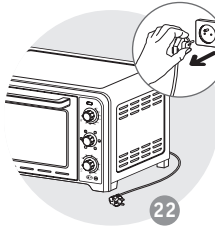

22

\*\* Блюдо не входит в комплект поставки  
Посуд не входит в комплект  
Төрөлме құрылғымен бірге  
қамтамасыз етілмейді  
The dish is not supplied with the appliance

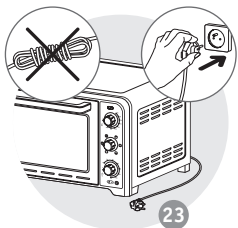

23

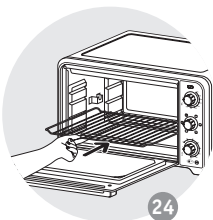

24

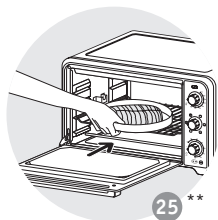

25 \*\*

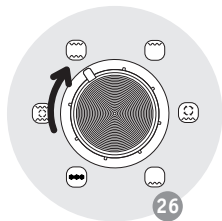

26

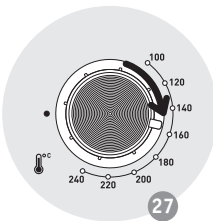

27

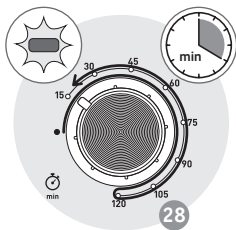

28

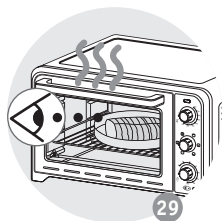

29

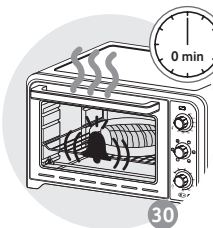

30

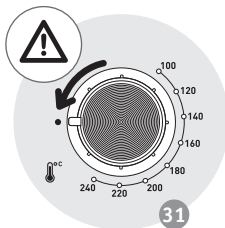

31

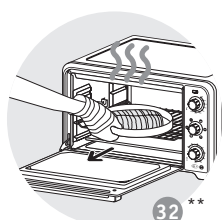

32 \*\*

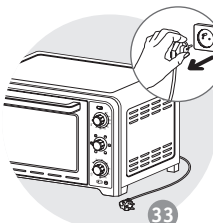

33

\*\* Блюдо не входит в комплект поставки  
Посуд не входит в комплект  
Төрөлме құрылғымен  
бірге қамтамасыз етілмейді  
The dish is not supplied with the appliance

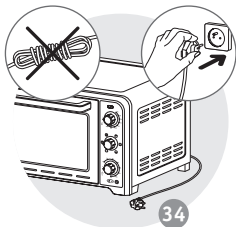

34

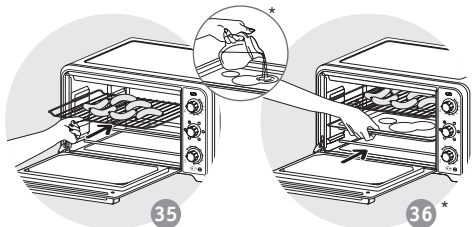

35

36\*

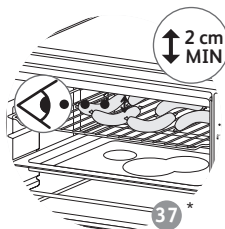

37\*

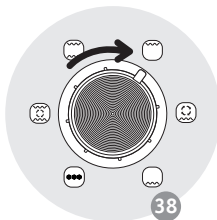

38

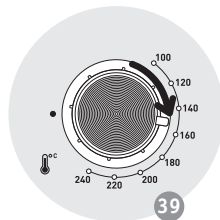

39

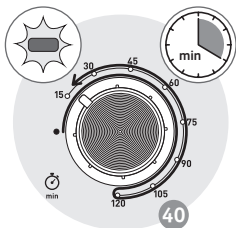

40

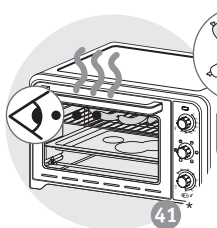

41\*

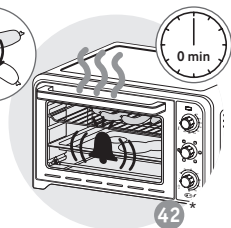

42\*

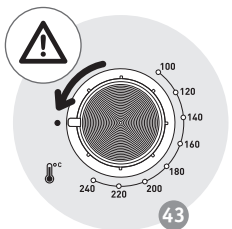

43

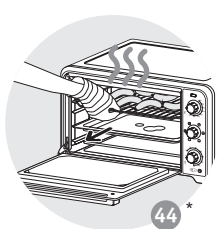

44\*

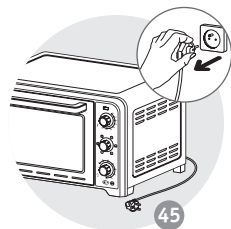

45

\* в зависимости от модели - Комплектація в залежності від моделі - улітге байланысты - depending on the model

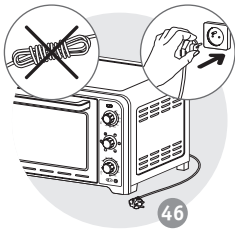

46

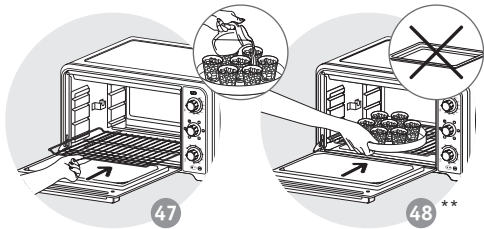

47

48 \*\*

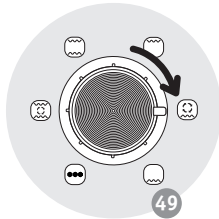

49

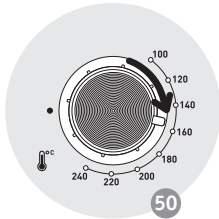

50

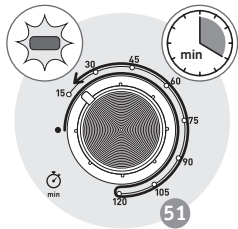

51

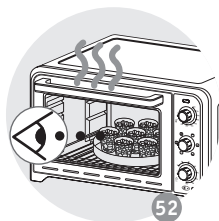

52

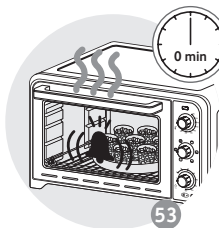

53

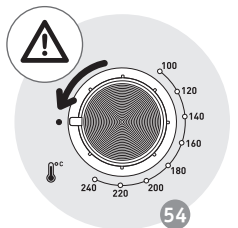

54

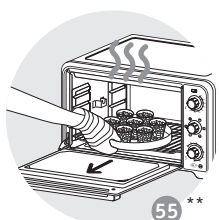

55 \*\*

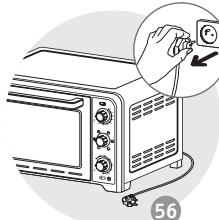

56

\*\* Блюдо не входит в комплект поставки  
Посуд не входит в комплект  
Төрөлме құрылғымен  
бірге қамтамасыз етілмейді  
The dish is not supplied with the appliance



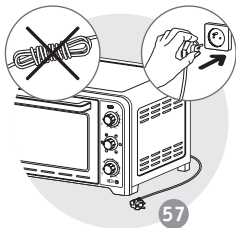

57

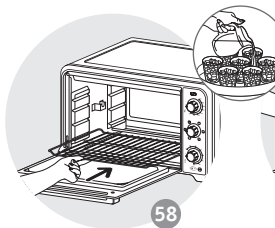

58

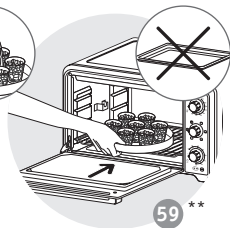

59 \*\*

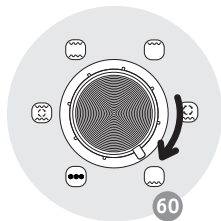

60

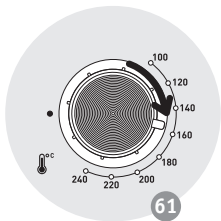

61

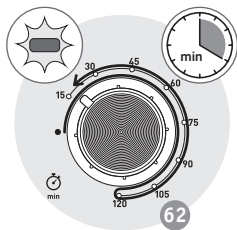

62

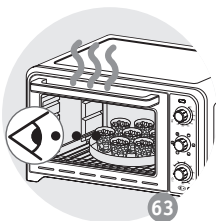

63

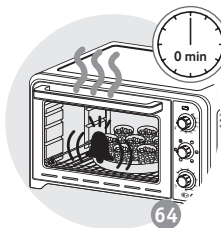

64

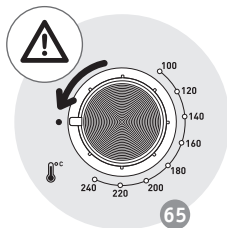

65

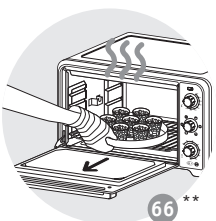

66 \*\*

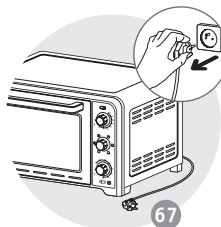

67

\*\* Блюдо не входит в комплект поставки  
Посуд не входит в комплект  
Төрөлме құрылғымен бірге  
қамтамасыз етілмейді  
The dish is not supplied with the appliance

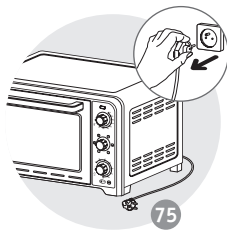
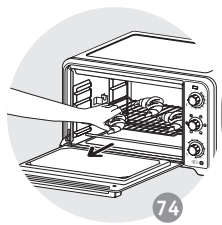
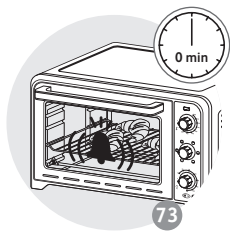
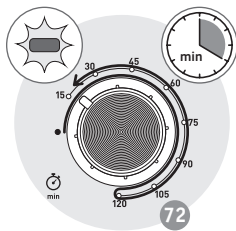
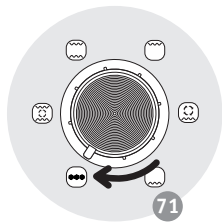
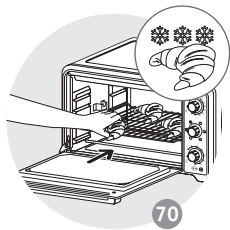
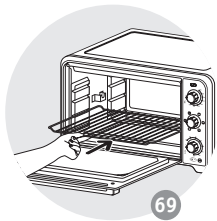
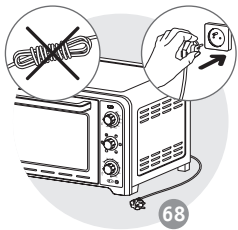

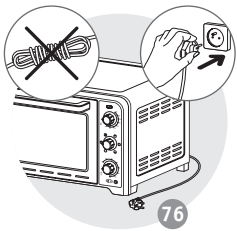

76

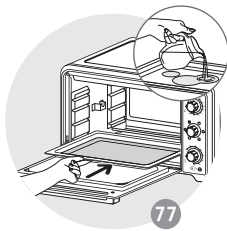

77

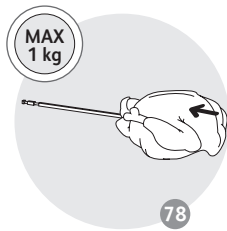

78

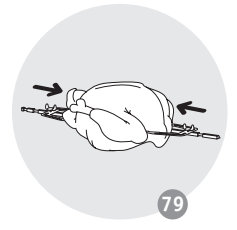

79

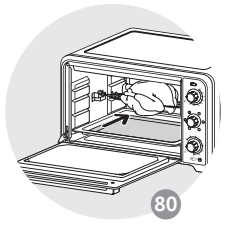

80

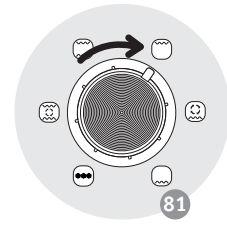

81

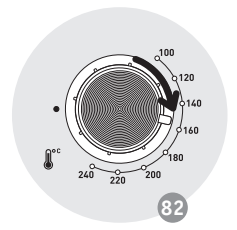

82

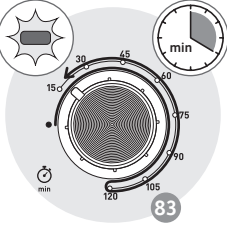

83

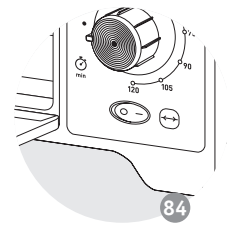

84

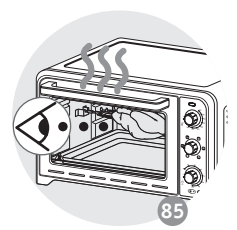

85

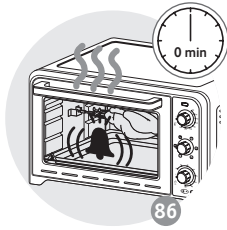

86

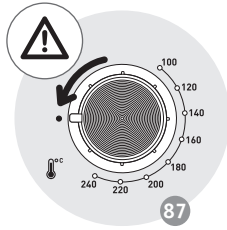

87

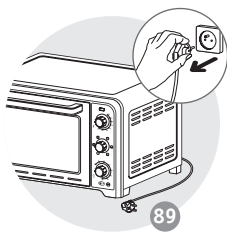
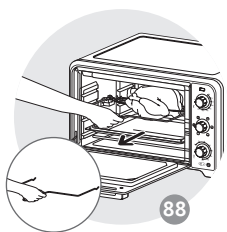

9

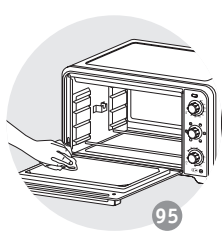
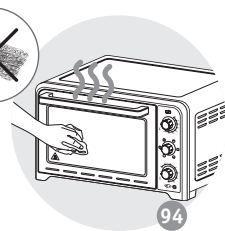
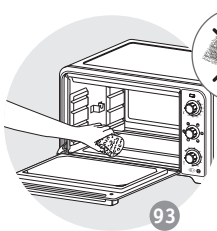
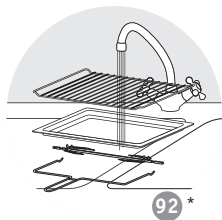
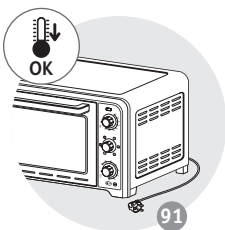
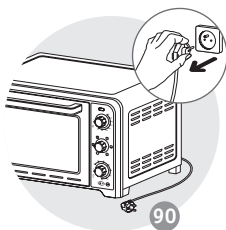

\* в зависимости от модели - Комплектація в залежності від моделі - улігге байлаанысты - depending on the model





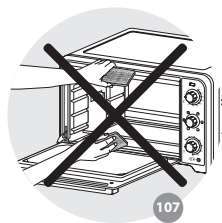
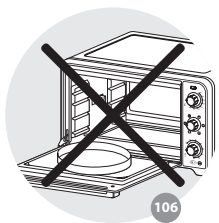
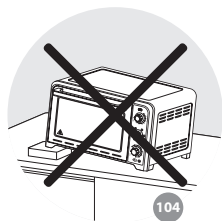
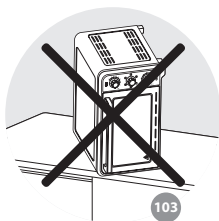
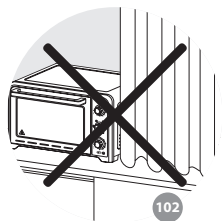
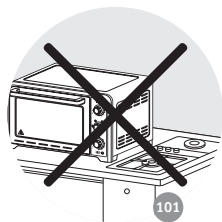
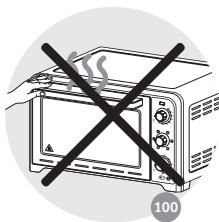
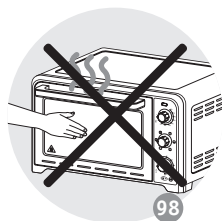
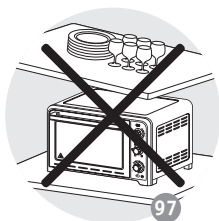
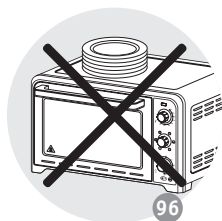

	x4			10mins	240 °C	18 mins
	870g			10mins	230 °C	45 mins
	750g			10mins	240 °C	30 mins
	500g			-	240 °C	55 mins
	1000g			-	240 °C	80 mins
	x4			-	240 °C	22 mins 
	x8			-	240 °C	15 mins 
	350g			10mins	240 °C	25 mins
				10mins	240 °C	40 mins
	350g			10mins	240 °C	15 mins
				-	240 °C	25 mins
				10mins	200 °C	42 mins
				10mins	200 °C	22 mins
				10mins	200 °C	35 mins
	x6			10mins	150 °C	25 mins
	x6			10mins	200 °C	18 mins
				10mins	230 °C	55 mins
				10mins	240 °C	25 mins
	750g			-	240 °C	50 mins



**MOULINEX INTERNATIONAL GUARANTEE: COUNTRY LIST**

www.moulinex.com

			
ARGENTINA	0800-122-2732	2 años 2 years	GRUPE SEB ARGENTINA S.A. Billinghurst 1833 3° C1425DTK Capital Federal Buenos Aires
ՀԱՅԱՍՏԱՆ ARMENIA	010 55-76-07	2 տարի 2 years	ՓԲԸ «ՀԳՐՈՒՊԻՊԱ ՍԵԲ» 125171,ՄՈՍԿՎԱ, ԼԵՆԻՆԳՐԱԴՍԿԱՆ, ԽՈՒՆՈՒՆ, 16A, ՇԻՆ.3
AUSTRALIA	1300307824	1 year	GRUPE SEB AUSTRALIA PO Box 7535, Silverwater NSW 2128
ÖSTERREICH AUSTRIA	01 890 3476	2 Jahre 2 years	GRUPE SEB DEUTSCHLAND GmbH / KRUPS GmbH Theodor-Stern-Kai 1 60486 Frankfurt am Main
البحرين BAHRAIN	17291537	1 year	www.moulinex-me.com
БЕЛАРУСЬ BELARUS	017 2239290	2 года 2 years	ЗАО «Группа СЕБ-Восток», 125171, Москва, Ленинградское шоссе, д. 16А, стр. 3
BELGIQUE BELGIE BELGIUM	070 23 31 59	2 ans 2 jaar 2 years	GRUPE SEB BELGIUM SA NV 25 avenue de l'Espérance - ZI 6220 Fleurus
BOSNA I HERCEGOVINA	Info-linija za potrošače 033 551 220	2 godine 2 years	SEB Development Predstavništvo u BiH Vrazova 8/II 71000 Sarajevo
BRASIL BRAZIL	11 2915-4400	1 ano 1 year	SEB COMERCIAL DE PRODUTOS DOMÉSTICOS LTDA Rua Venâncio Aires, 433, Pompéia, São Paulo/SP
БЪЛГАРИЯ BULGARIA	0700 10 330	2 години 2 years	ГРУП СЕБ БЪЛГАРИЯ ЕООД бул. България 81 В, ет. 5 1404 София
CANADA	1-800-418-3325	1 an 1 year	GRUPE SEB CANADA 345 Passmore Avenue Toronto, ON, M1V 3N8
CHILE	02 2 884 46 06	2 años 2 years	GRUPE SEB CHILE Comercial Ltda Av. Providencia, 2331, piso 5, oficina 501 Santiago
COLOMBIA	018000520022	2 años 2 years	GRUPE SEB COLOMBIA Apartado Aereo 172, Kilometro 1 Via Zipaquira, Cajica Cundinamarca
HRVATSKA CROATIA	01 30 15 294	2 godine 2 years	SEB mku & p d.o.o. Sarajevska 29, 10000 Zagreb
ČESKÁ REPUBLIKA CZECH REPUBLIC	731 010 111	2 roky 2 years	Grupe SEB ČR s.r.o. Futurama Business Park (budova A) Sokolovská 651/136a 186 00 Praha 8
DANMARK DENMARK	44 663 155	2 år 2 years	GRUPE SEB NORDIC AS Tempovej 27 2750 Ballerup
مصر EGYPT	16622	سنة واحدة 1year	جروب سب إيجيبت القاهرة: ١٢١ شارع الحجاز، مصر الجديدة (الإسكندرية): طريق ٤ مايو، سموحة
EESTI ESTONIA	668 1286	2 aastat 2 years	GRUPE SEB POLSKA Sp. z o.o. ul. Bukowińska 22b 02-703 Warszawa
SUOMI FINLAND	09 622 94 20	2 Vuotta 2 years	Grupe SEB Finland Kutojanitie 7 02630 Espoo
France Continentale + Guadeloupe, Martinique, Réunion, Saint-Martin	09 74 50 10 14	2 ans 2 years	GRUPE SEB France Service Consommateur Moulinex 112 Ch. Moulin Carron, TSA 92002 69134 ECULLY Cedex
DEUTSCHLAND GERMANY	0212 387 400	2 Jahre 2 years	GRUPE SEB DEUTSCHLAND GmbH / KRUPS GmbH Theodor-Stern-Kai 1 60486 Frankfurt am Main

ELLADA GREECE	2106371251	2 χρόνια 2 years	SEB GROUPE ΕΛΛΑΔΟΣ Α.Ε. Οδός Καβαλιεράδου 7 Τ.Κ. 145 64 Κ. Κηφισιά
香港 HONG KONG	8130 8998	1 year	SEB ASIA Ltd. Room 903, 9/F, South Block, Skyway House 3 Sham Mong Road, Tai Kok Tsui, Kowloon, Hong-Kong
MAGYARORSZÁG HUNGARY	06 1 801 8434	2 év 2 years	GROUPE SEB CENTRAL-EUROPE Kft. Táviró köz 4 2040 Budaörs
INDONESIA	+62 21 5793 7007	1 year	GROUPE SEB INDONESIA (Representative office) Sudirman Plaza, Plaza Marein 8th Floor JL Jendral Sudirman Kav 76-78, Jakarta 12910, Indonesia
ITALIA ITALY	1 99 207 892	2 anni 2 years	GROUPE SEB ITALIA S.p.A. Via Montefeltro, 4 20156 Milano
日本 JAPAN	0570-077772	1 year	株式会社グループセブジャパン 〒144-0042 東京都大田区羽田旭町11-1 羽田クロノゲート事務棟5F
الأردن JORDAN	4629700	1 year	www.moulinex-me.com
ҚАЗАҚСТАН KAZAKHSTAN	727 378 39 39	2 жыл 2 years	ЖАҚ «Группа СЕБ- Восток» 125171, Москва, Ленинградское шоссе,16А, 3 үйі
한국어 KOREA	1588-1588	1 year	(유)그룹 세브 코리아 서울시 중로구 청계천로35 관정빌딩 2층 110-790
الكويت KUWAIT	24834787	1 year	www.moulinex-me.com
LATVJA LATVIA	6 616 3403	2 gadi 2 years	GROUPE SEB POLSKA Sp. z o.o. ul. Bukowińska 22b, 02-703 Warszawa
لبنان LEBANON	1364392	1 year	www.moulinex-me.com
LIEUVA LITHUANIA	5 214 0057	2 metai 2 years	GROUPE SEB POLSKA Sp. z o.o. ul. Bukowińska 22b, 02-703 Warszawa
LUXEMBOURG	0032 70 23 31 59	2 ans 2 years	GROUPE SEB BELGIUM SA NV 25 avenue de l'Espérance - ZI 6220 Fleurus
МАКЕДОНИЈА MACEDONIA	(02) 20 50 319	2 години 2 years	ГРУП СЕБ БЪЛГАРИЈА ЕООД бул. България 81 В, ет. 5 1404 София
MALAYSIA	603 7802 3000	1 year	GROUPE SEB MALAYSIA SDN. BHD Unit No. 402-403, Level 4, Uptown 2, No. 2, Jalan SS21/37, Damansara Uptown, 47400, Petaling Jaya, Selangor D.E. Malaysia
MEXICO	(01800) 112 8325	1 año 1 year	Groupe S.E.B. México, S.A. DE C.V. Goldsmith 38 Desp. 401, Col. Polanco Delegación Miguel Hidalgo 11 560 México D.F.
MOLDOVA	22 929249	2 роки 2 years	ТОВ «Грун СЕБ Україна» 02121, Харьковське шосе, 201-203, 3 поверх, Київ, Україна
NEDERLAND The Netherlands	0318 58 24 24	2 jaar 2 years	GROUPE SEB NEDERLAND B.V. De Schutterij 27 3905 PK Veenendaal
NEW ZEALAND	0800 700 711	1 year	GROUPE SEB NEW ZEALAND PO Box 17 – 298, Greenlane, 1546 Auckland New Zealand



NORGE NORWAY	815 09 567	2 år 2 years	GRUPE SEB NORDIC AS Tempovej 27 2750 Ballerup
عمان سلطنة OMAN	80075000	1 year	www.moulinex-me.com
POLSKA POLAND	801 300 420 koszt jak za połączenie lokalne	2 lata 2 years	GRUPE SEB POLSKA Sp. z o.o. ul. Bukowińska 22b 02-703 Warszawa
PORTUGAL	808 284 735	2 anos 2 years	GRUPE SEB IBÉRICA SA Urb. da Matinha Rua Projectada à Rua 3 Bloco1 - 3° B/D 1950 - 327 Lisboa
قطر QATAR	44558796	1 year	www.moulinex-me.com
REPUBLIC OF IRELAND	01 677 4003	1 year	GRUPE SEB IRELAND Unit B3 Aerodrome Business Park, College Road, Rathcoole, Co. Dublin
ROMANIA	0 21 316 87 84	2 ani 2 years	GRUPE SEB ROMÂNIA Str. Emil Pangratti nr. 13 011881 București
РОССИЯ RUSSIA	495 213 32 29	2 года 2 years	ЗАО «Группа СЕБ-Восток», 125171, Москва, Ленинградское шоссе, д. 16А, стр. 3
السعودية العربية المملكة SAUDI ARABIA	920023701	2 years	www.moulinex-me.com
SRBIJA SERBIA	060 0 732 000	2 godine 2 years	SEB Developpement Đorđa Stanojevića 11b 11070 Novi Beograd
SINGAPORE	6550 8900	2 years	GRUPE SEB SINGAPORE Pty Ltd. 59 Jalan Pemimpin, #04-01/02 L&Y Building Singapore 577218
SLOVENSKO SLOVAKIA	232 199 930	2 roky 2 years	GRUPE SEB Slovensko, spol. s r.o. Cesta na Senec 2/A 821 04 Bratislava
SLOVENIJA SLOVENIA	02 234 94 90	2 leti 2 years	SEB d.o.o. Gregorčičeva ulica 6 2000 MARIBOR
SOUTH AFRICA	0100201730	1 year	GS South Africa Building 17, PO BOX 107 The Woodlands Office Park, 20 Woodlands Drive, Woodmead 2080
ESPAÑA SPAIN	902 31 22 00	2 años 2 years	GRUPE SEB IBÉRICA S.A. C/ Almogàvers, 119-123, Complejo Ecurban, 08018 Barcelona
SVERIGE SWEDEN	08 594 213 30	2 år 2 years	TEFAL SVERIGE SUBSIDIARY OF GROUPE SEB NORDIC Truckvägen 14 A, 194 52 Upplands Väsby
SUISSE SCHWEIZ SWITZERLAND	044 837 18 40	2 ans 2 Jahre 2 years	GRUPE SEB SCHWEIZ GmbH Thurgauerstrasse 105 8152 Glattpark
ประเทศไทย THAILAND	02 769 7477	2 years	GRUPE SEB THAILAND 2034/66 Italthai Tower, 14th Floor, n° 14-02, New Phetchburi Road, Bangkapi, Huaykwang, Bangkok, 10320
TÜRKIYE TURKEY	444 40 50	2 YIL 2 years	GRUPE SEB ISTANBUL AS Dereboyu Cd. Bilim Sk. Sun Plaza No:5 K:2 Masiak 34398 Istanbul

المملكة العربية الإمارات UAE	8002272	1 Year	www.moulinex-me.com
Україна UKRAINE	044 300 13 04	2 роки 2 years	ТОВ «Групи СЕБ Україна» 02121, Харківське шосе, 201-203, 3 поверх, Київ, Україна
UNITED KINGDOM	0345 602 1454	1 year	GROUPE SEB UK LTD Riverside House, Riverside Walk Windsor, Berkshire, SL4 1NA
U.S.A.	800-395-8325	1 year	GROUPE SEB USA 2121 Eden Road Millville, NJ 08332
VENEZUELA	0800-7268724	2 años 2 years	GROUPE SEB VENEZUELA Av Eugenio Mendoza, Centro Letonia, Torre ING Bank, Piso 15, Ofc 155 Urb. La Castellana, Caracas

www.moulinex.com

22/12/2015

## MOULINEX INTERNATIONAL GUARANTEE

**Date of purchase:** ..... / Date d'achat / Fecha de compra / Data da compra / Data d'acquisto / Kaufdatum / Aankoopdatum / Købsdato / Inköpsdatum / Kjøpsdato / Ostupňavň / Data zakupu / Data vňzãrni / [sigijimo data] Ostukupljev / Datum nakupa / Sorozatszám / Datum nakupa / Pirkuma datums / Datum Kupovine / Datum kupnje / Data cumpãrãrii / Datum nákupu / Tariħ pembelian / Tanggal pembelian / Ngay mua hãng / Satın alma tarihi / [Data prodazh] / Data na zakupovãne / Datum na kupovãne / Саткован мерени / Ημερομηνία αγοράς / Ημερομηνία οργ / 購買日期 / 購入日 / 구입일지 / تاريخ الشراء / تاريخ خري /

**Product reference:** ..... / Référence du produit / Referencia del producto / Nome do produto / Tipo de produto / Typnummer des Gerätes / Artikelnummer van het apparaat / Referencenummer / Produktreferens / Artikelnummer / Tuotenumero / referenja produktu / Model / Gaminio numeris / Toote viitenumber / Tip aparata / Vásãrlãs keltã / Typ vjrobku / Produkta atsauceš numurs / Model proizvoda / Oznaka proizvoda / Cod produs / Produk rujukan / Referens produkt / Mã sản phẩm / Ürün kodu / Model / Модел / Модел на уредã / Модел / Кодовъс кодификация / Унић / 產品型號 / 製品レファレンス番号 / 제품명 / مرجع المنتج / 莫德爾 /

**Retailer name & address:** ..... / Nom et adresse du vendeur / Nombre y dirección del minorista / Nome e endereço do revendedor / Nome e indirizzo del negozio / Name und Anschrift des Hãndlers / Naam en adres van de dealer / Forhandler navn & adresse / Återfãrsãlljãrens namn och adress / Forhandler navn og adresse / Jãllentemyyãn nimi ja osoite / nazwa i adres sprzedawcy / Numele și adresa vânzãtorului / Pardautãvãs pavãdãnimãs ir adresas / Mijãta kauplus ja address / Naziv in naslov trgovine / Tjuppsãzãm / Nãzov a adresa prodãvã / Veikala nosaukums un adrese / Naziv i adresa prodavca / Naziv i adresa prodavca / Naziv i adresa prodajnog mjesta / Nume și adresã vânzãtor / Nãzev a adresa prodãvã / Nama dan alamat penjual / Nama Toko Penjual dan alamat / Tên và địa chỉ của hãng bán / Sãtes firmãm adã ve adresa / Hãzãnoime nã adresã prodãvã / Hãma i adresa prodãvã / Търговски обект / Hãma i adresa na prodãvnãnãta / Сагуваннямã ага жãзе мекã-зãлля / Еπωρησιã και δελτιωμενã κοινησησηση / 售賣商名稱及地址 / 售賣商名稱和地址 / 販売店の名前、住所 / 소매점 이름과 주소 / ماعز خردفرو / مغازه / نام تãرس خردفرو / مغازه / نام التجره و عنوانه / اسم باع التجرة /

**Distributor stamp:** ..... / Cachet distributeur / Sello del distribuidor / Carimbo do revendedor / Timbro del negozio / Hãndlerstempel / Stempel van de dealer / Forhandler stempel / Återfãrsãlljãrens stãmpel / Forhandler stempel / Jãllentemyyãn leima / pieczãtã sprzedawcy / Štãmpila vãnzãtorului / Antspãdas / Tempel / Žig trgovine / Elãdo neve, cím / Raziko prodãvã / Zimops / Peãatã malprodãvã / Peãatã prodãvã / Peãatã prodajnog mjesta / Štãmpila vãnzãtorului / Raziko prodãvã / Carã perniã / Carã dari Toko Penjual / Cũa hãng bán đõng dấu / Sãtes Firmãm Kašesi / Печãтка prodãvã / Печãтка prodãvã / Печатã na търговския обект / Печатã na prodãvnãnãta / Сагуваннямã мори / Σαγγελιωμã κοινησησηση / 售賣商印 / 售賣商印 / 販売店印 / 소매점 직인 / مهر خردفرو / مغزه / نام باع التجرة /



9100021926